

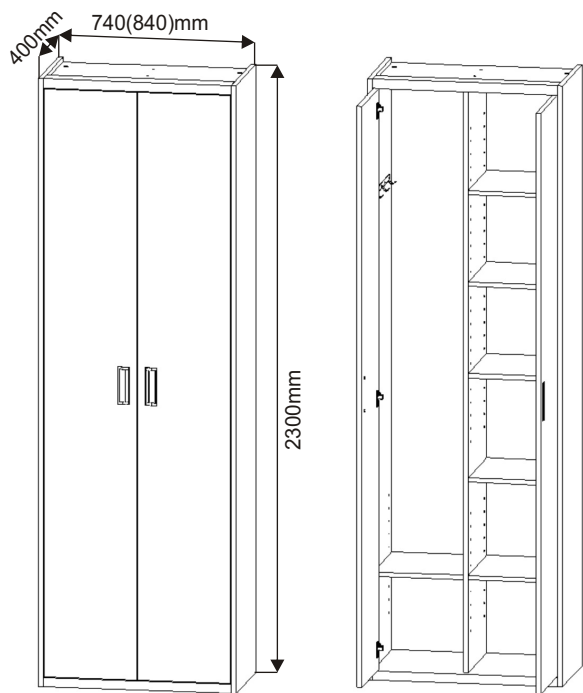









**SVV 740 a SVV 840 Hochregalschrank
für VS21075, VS21058, VS21054**

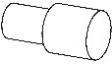

der Halter +die Zierschraube 16mm  4x 2x	Exzenter 16x  16x	Einschraub- dübel 16x  16x
--	---	---

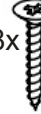
Topfscharnier einliegend mit integrierter dämpfung 6x 	der Stift 35mm 24x 	die Regalstütze 20x 	die Schrauben- abdeckung 22x 
---	---	--	--

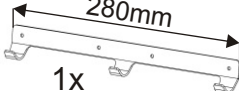
der Nagel 80x 	V4x16 28x 	V4x35 6x 	Dreifach-Aufhänger 280mm 1x 
---	---	--	--

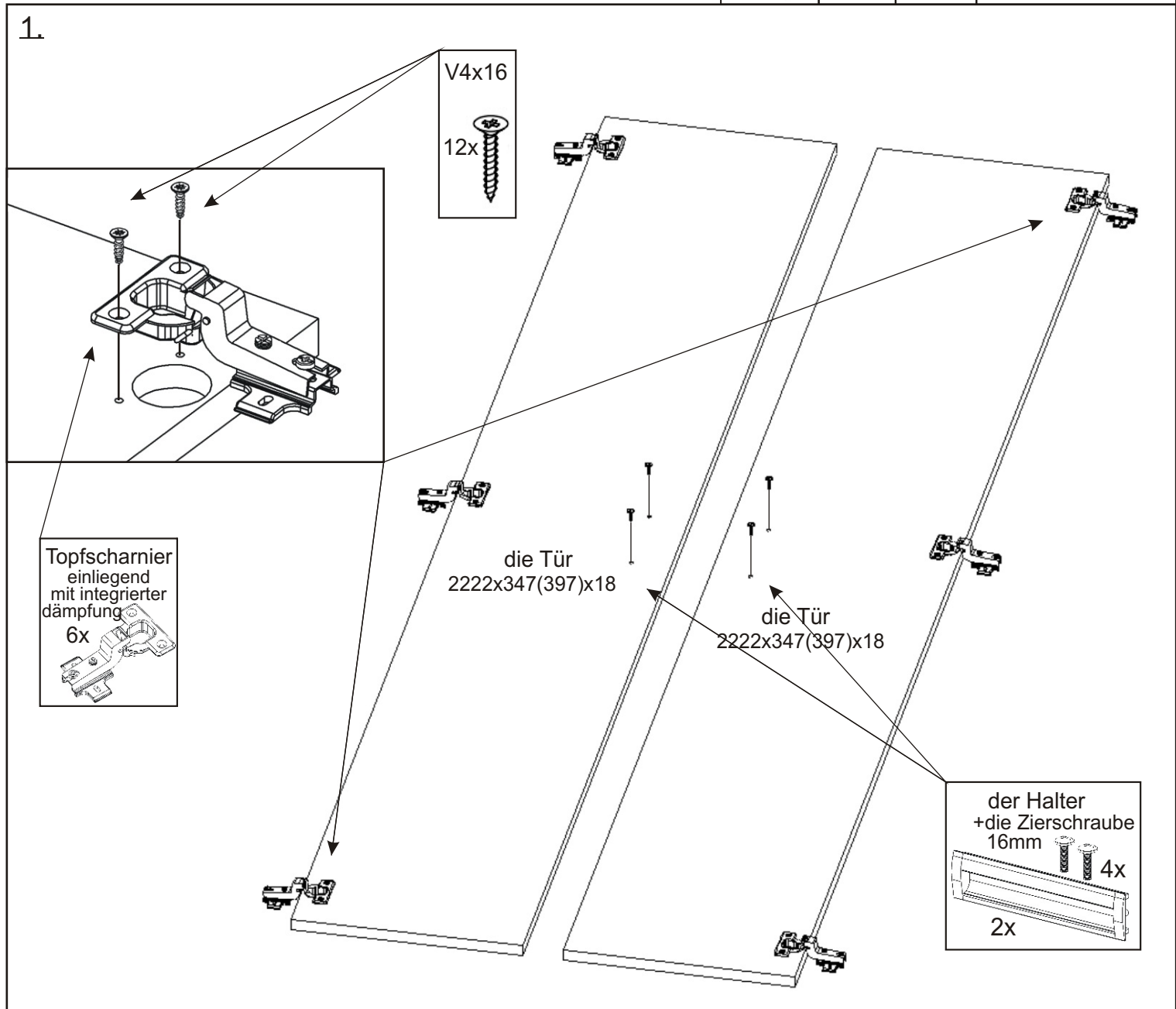

2.

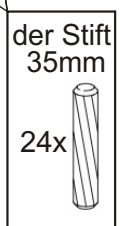
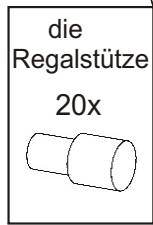
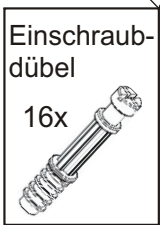
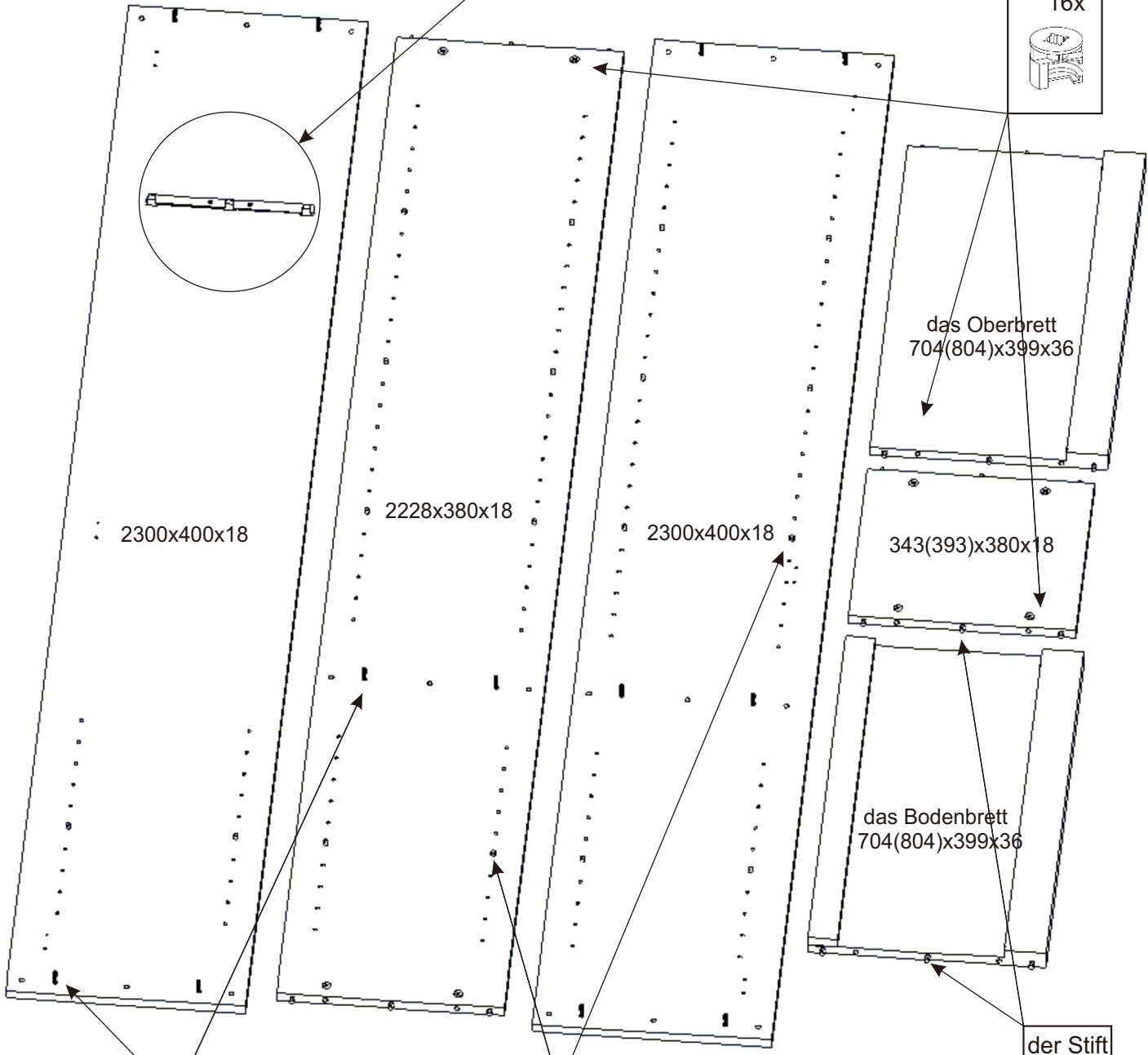
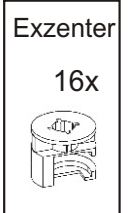
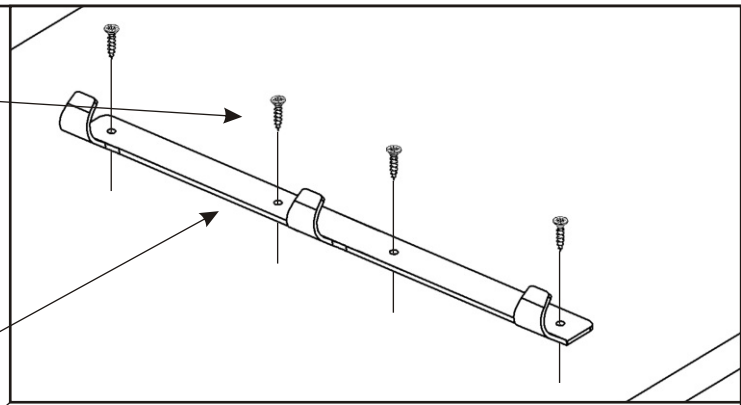
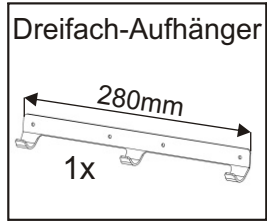
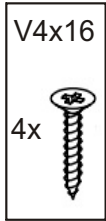

3.

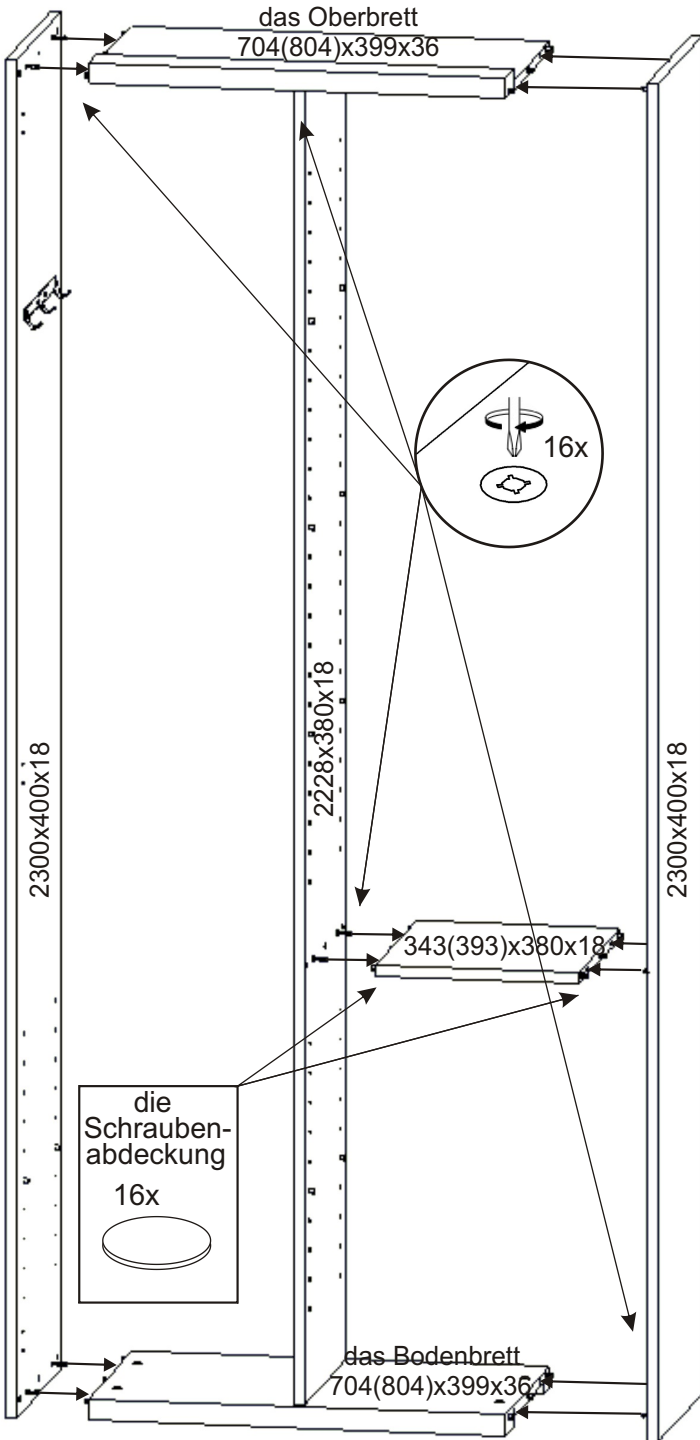

4.

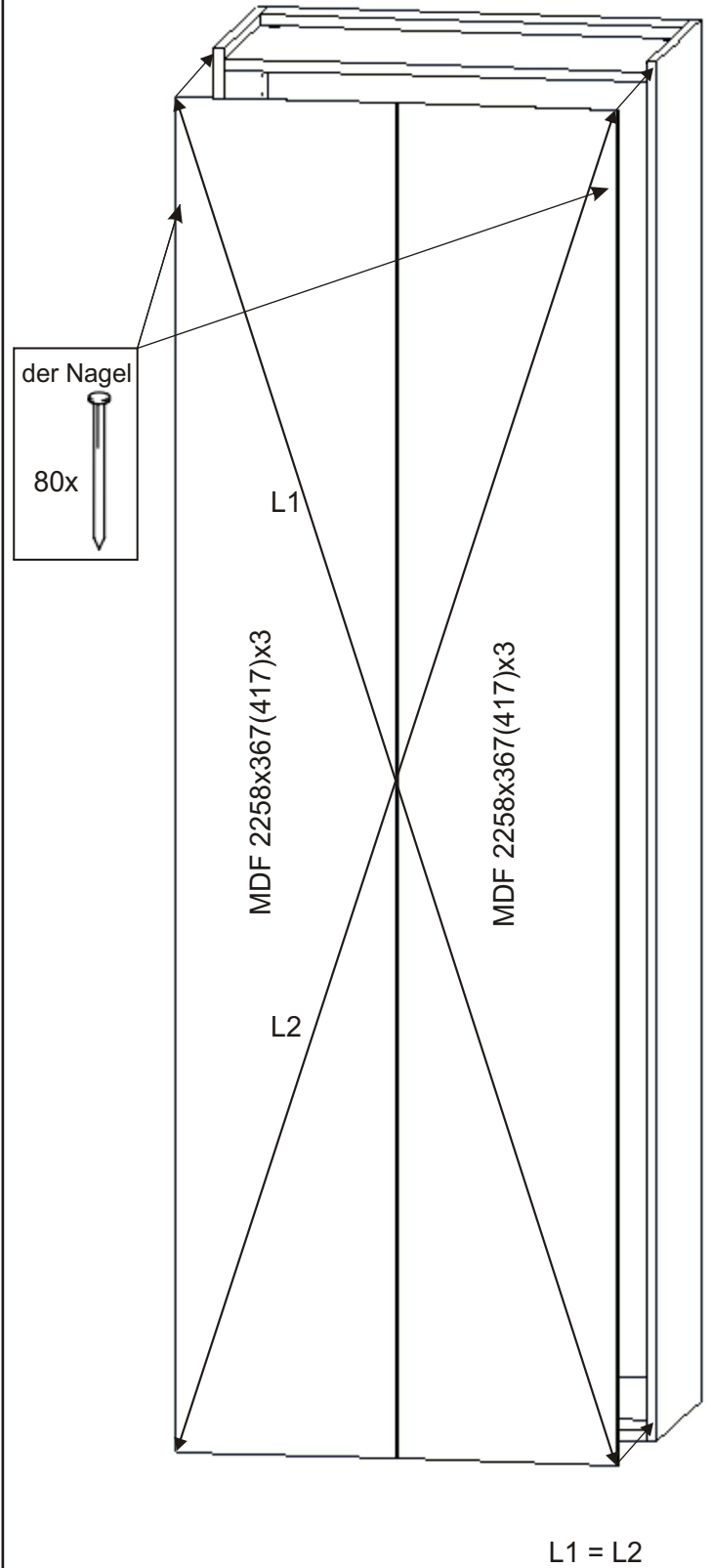

5.

Der Kleiderschrank kann am Schrankbett oder am Kleiderschrank in der Montage befestigt werden mit 4x35 Schrauben.

